



Received: 20 April 2016  
Accepted: 15 October 2016  
First Published: 21 October 2016

\*Corresponding author: M.F. Akorede,  
Department of Electrical and Electronics  
Engineering, University of Ilorin, Ilorin,  
Nigeria  
E-mails: [mudathira30@gmail.com](mailto:mudathira30@gmail.com),  
[akorede@unilorin.edu.ng](mailto:akorede@unilorin.edu.ng)

Reviewing editor:  
Qingsong Ai, Wuhan University of  
Technology, China

Additional information is available at  
the end of the article

## ELECTRICAL & ELECTRONIC ENGINEERING | RESEARCH ARTICLE

# Unit commitment optimisation of hydro-thermal power systems in the day-ahead electricity market

S.A. Bello<sup>1</sup>, M.F. Akorede<sup>1\*</sup>, E. Pournesmaeil<sup>2</sup> and O. Ibrahim<sup>1</sup>

**Abstract:** Unit commitment is one of the serious major problems encountered in power system operation, control and coordination. It is a complex non-linear problem used in the schedule of operation of generating units at minimum operating cost. This paper presents a new formulation and classical exhaustive enumeration search method for the well-known unit commitment problem for scheduling thermal and hydroelectric power generating units in a day-ahead electricity market. In the study, the two objective functions formulated are minimisation of total production cost and maximisation of the energy consumption. To effectively deal with the constraints of the problem, the difficult minimum up/down-time constraints of thermal generation units and the turbine operating constraint of hydropower stations are embedded in the binary strings that are coded to represent the on/off-states of the generating units. The Nigeria 330 kV power system containing four thermal and three hydropower plants is studied under different scenarios for a 24 h horizon to show the effectiveness of the proposed algorithm. Although the approach is not really computationally efficient compared to some methods, a high accuracy of optimal solution is guaranteed. The results obtained in the study are compared with the ones reported in the literature, which confirm the effectiveness of the proposed technique.

### ABOUT THE AUTHORS

S.A. Bello just completed his master degree programme in Electrical and Electronics Engineering at the University of Ilorin, Ilorin, Nigeria. His research interests are in power systems coordination, planning and control and their applications.

M.F. Akorede is a senior lecturer and head, Department of Electrical and Electronics Engineering, University of Ilorin, Ilorin, Nigeria. His main research interest is optimisation of distributed energy resources in power systems.

E. Pournesmaeil is a senior researcher with the Institute Super Tecn Lisbon (INESC-ID), Portugal. His research interests include application and control of power converters in intelligent power systems.

O. Ibrahim is a lecturer at the Department of Electrical and Electronics Engineering, University of Ilorin, Ilorin, Nigeria. He is currently pursuing his PhD degree at Universiti Teknologi PETRONAS Malaysia. His research interests include dynamics and control of power converters.

### PUBLIC INTEREST STATEMENT

Operation of thermal power plants is becoming more costly as the resources involved are becoming scarce and expensive. At the same time, the electric power industry is fast moving from the traditional monopolistic environment to a competitive market. The demand for electricity varies with time and increases as the population growth increases. The consumers need regular, reliable and quality supply while the aim of the electric utilities is to maximise profit. Hence, the need to effectively utilise the available scarce resources by the power system operators to develop a scheduled plan and control to produce the required energy at the minimum cost, having considered other factors of production of electricity. To achieve this, an optimal schedule is developed in this study to decide on the generator(s) to dispatch, the quantity of power to be produced, and the time of the day and duration to commit each generator.

**Subjects: Renewable Energy; Energy & Fuels; Power Engineering**

**Keywords: unit commitment; economic dispatch; exhaustive enumeration algorithm; operational planning; hydro-thermal**

### 1. Introduction

Power systems operational planning is necessary for the best utilisation of the available energy resources to meet the varying load demand with maximum safety of equipment and personnel involved at the minimum cost without violating any system constraints. Adequate planning therefore results in optimal unit commitment (UC) which gives great savings for the electric utilities. Moreover, the rate at which electric power industry changes rapidly from the traditional monopolistic market to a competitive market also calls for operating strategies to meet the fluctuating demand for electricity over a specific time, long or short.

However, the non-storable nature of the electric power makes it a challenge to meet the load demand at any time instant. Unit commitment is therefore used to determine when generating units are to be switched ON/OFF known as *start-up* and *shut-down* schedules in order to meet the forecasted load demand which changes with time (Wood & Wollenberg, 1996). While meeting the load demand, equality and inequality constraints must be satisfied without prejudice to other units characteristics, such as the *must-run* units, unit availability, and unit dispatch order, amongst others. Units designated as *must-run* are always fully or partially dispatched. This can be due to environmental impact, logical reasoning or its operational status to provide generation and/or transmission support. In the case of dispatch order, a preference manner of dispatching the available units must be adopted, which usually depends largely on the nature of the plant and operator in charge. Unit availability is to be considered particularly when some units are off-line due to maintenance, repair or for any other reasons. Therefore, dispatch must be based on the available units to meet the demand in the most effective manner. These and many other factors result in a mixed combinatorial problem which determines the state of the units to be either ON or OFF (Balci & Valenzuela, 2004).

Solving UC problem in power systems containing hydro and thermal generating units results in minimisation of the total production cost with a better accuracy of the ON/OFF status of each unit without any prejudice to the load demand. However, a general hypothesis has confirmed that hydro units do not pose any serious cost effect on the generation of electric power; hence they are employed to regulate the peak system demand, thereby reducing the fuel cost to be incurred in running thermal units (El-Hawary & Christenson, 2012; Kluabwang, 2012; Puri, Narang, Jain, & Chauhan, 2012).

In addressing the UC problem, a number of methods, categorised into classical, non-classical and hybrid methods have been employed in the previous works. The classical methods include priority list (Tingfang & Ting, 2008), dynamic programming (Ouyang & Shahidehpour, 1991), Lagrange relaxation method (Yan, Luh, Guan, & Rogan, 1993), amongst others. These methods are heuristic with dimensionality problem. The non-classical methods include Tabu search (Kluabwang, 2012), Heuristic Algorithm (Najafi & Pourjamal, 2012; vol. 14), artificial neural network (ANN) (Yalcinoz, Cory, & Short, 2001) particle swarm optimization (PSO) (Bai, 2010; Revathy & Nithyanandham, 2014), genetic algorithm (Orero & Irving, 1998), fuzzy logic (Dhillon, Parti, & Kothari, 2001), integer-coded genetic algorithm (Ioannis, Anastasios & Petros, 2004), parallel nodal ant colony optimization approach (Columbus & Simon, 2013) amongst others. The non-classical methods proffer solutions to problems that might be encountered by classical methods. To improve the performance of the single approach and get a better quality of solution, the combination of two or more methods from the classical and or non-classical methods gives the hybrid approach. Some of the hybrids that have been engaged include hybrid of PSO and Lagrange relaxation (Jeong, Park, Jang, & Lee, 2010), simulated annealing/genetic algorithm hybrid (Yin Wa Wong, 2001), hybrid fuzzy simulated annealing (Saber, Senjyu, Miyagi, Urasaki, & Funabashi, 2006) and Lagrange relaxation combined with evolutionary programming (Bavafa, Monsef, & Navidi, 2009), amongst others.

This paper presents an exhaustive enumeration algorithm (EEA) for optimal combination of the units. The proposed method generates better solutions in many cases especially when dealing with power systems that have less than 20 units as it creates all possible alternatives of the solution (Bayoumi, 2014). The other part of this paper is organised as follows: Section 2 explains the unit commitment problem formulation and Section 3 gives a brief overview of the EEA method, as Section 4 describes the case study system and data. Results and discussion are presented in Section 5 while Section 6 draws the conclusion to the study.

## 2. Problem formulation

The demand for electricity is higher during the daytime especially at peak periods and lower at off peak periods. This cyclical nature of the demand requires that the utility companies plan for generation of power on hourly basis taking into consideration all necessary constraints. To meet the power demand at the minimum operation cost in a secured and economic manner, the electric utility has to decide the unit to start up, when to tie such unit, and the unit to shut down and for how long. The computational procedure for making such decision, known as unit commitment is formulated mathematically as a bi-objective or multi-objective function problem in this work.

### 2.1. Minimisation of total production cost

In the objective function, all costs incurred in power production by both thermal and hydro units are to be minimised at an optimal output of the units in the system.

Mathematically, the objective function is formulated as

$$A_1 = \theta + \phi \tag{1}$$

where  $\theta$  is the cost of running thermal units and  $\phi$  is cost of running hydro units.

**(a) Cost of running thermal units,  $\theta$ :** The cost of running thermal unit includes costs of fuel, unit start up and short down, operation and maintenance and crew. Any other cost may either be included or excluded from the objective function according to the system operators' demand with different weights. A number of variables that affect the operation cost include generator distance from load, type of fuel, load capacity, among others (Zivic, Milacic, & Krsulja, 2012).

Equation (2) presents the composition of cost incurred in running thermal units.

$$\theta = F + S + D + C \tag{2}$$

where,  $F$  is the fuel cost,  $S$  is the startup cost,  $D$  is the shutdown cost and  $C$  is crew cost.

**(i) Fuel cost:** The fuel cost is expressed as a second order quadratic cost function as presented in Equation (3) which comprises the heat rate of unit and fuel price.

$$F_j^t = \sum_{t=1}^{24} \sum_{j=1}^Q \left[ \left( \alpha_j + B_j P_j^t + \gamma_j (P_j^t)^2 \right) P_j^t \right] \tag{3}$$

**(ii) Start-up cost:** The startup cost is the cost incurred when switching ON the thermal units. This cost could either be cold ( $k$ ) or banked ( $B$ ) startup.

**(iii) Cold start-up cost:** Cold startup cost is the cost incurred when a unit that has been off-line for a time far greater than its minimum down time is to be re-committed. It is formulated as presented in Equation (4).

$$k = \left( 1 - e^{-t_j/\tau_j} \right) F_j^t + C \tag{4}$$

It is worth mentioning that as the unit's cooling time increases, the exponential component of the expression tends to zero.

**(iv) Banked start-up cost:** When the unit that has satisfied the minimum down time has just been shut down, the cost incurred to recommit such unit is called banked start-up cost. For banked start-up, the units are still in possession of their operating temperature. The expression for this cost is presented in Equation (5).

$$B = O_j^t + C \tag{5}$$

Therefore the thermal running cost is presented in Equation (6).

$$\theta = \sum_{t=1}^{24} \sum_{j=1}^Q \left[ F_j^t U_j^t + S_j^t U_j^t + D_j^t U_j^t \right] + C \tag{6}$$

**b. Cost of running hydro units:** The major cost in running the hydro units,  $\phi$ , is crew cost. In this case  $C_h$  is used to depict hydro power crew cost as shown in Equation (7).

$$\phi = \sum_{h=1}^M C_h \tag{7}$$

Therefore, from Equations (6) and (7), the total cost of production,  $A_1$ , to be minimised, is presented in Equation (8). This objective function is further expanded as shown in Equation (9).

$$A_1 = \sum_{t=1}^T \sum_{i=1}^N \left[ \theta_j^t + \phi_h^t \right] \tag{8}$$

where,  $i = j + h$

**Figure 1. Hierarchical structure of the costs.**

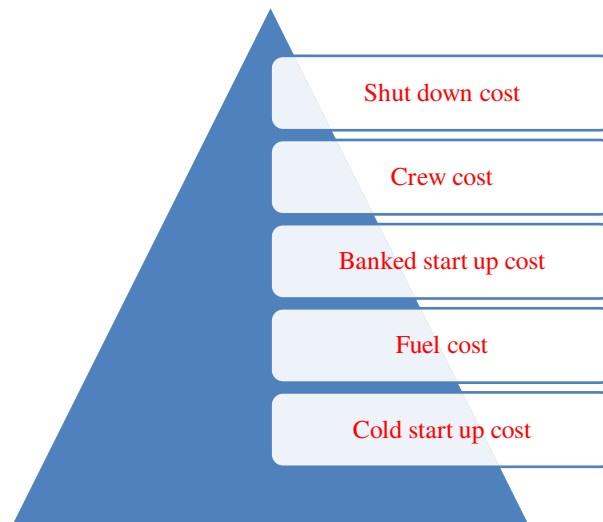

$$\text{Min } A_1 = \sum_{t=1}^T \left[ \left\{ \sum_{j=1}^Q F_j^t U_j^t + S_j^t U_j^t + D_j^t U_j^t \right\} + \sum_{h=1}^M C_h \right] + C \quad (9)$$

where, C is the total crew cost incurred on all the units.

Figure 1 presents the rate at which each of the above discussed costs is incurred in power system operation. The highest cost is incurred when thermal unit is starting with cold start and least when shorting down the unit, which is usually zero in reality.

### 2.2. Minimisation of unexpected deviation

The system disturbance caused by unsatisfied load as a result of insufficient generation or unconsumed power generated due to excess generation is to be minimised. Moreover, the total power generated that will meet the demand at a minimum deviation has to be minimised. This is called unexpected deviation,  $A_2$ , presented by Equation (10).

$$\text{Min } A_2 = \sum_{t=1}^T \sum_{i=1}^N P_i^t \quad (10)$$

where N is the total number of units in the system.

Logically, minimisation of the unexpected deviation is equivalent to maximisation of energy consumption. Hence, the aggregate bi-objective problem formulation can be defined as follows in Equation (11).

$$\text{Obj} = \min(A_1, A_2) \quad (11)$$

#### 2.2.1. System constraints

The system constraints considered in this work are divided into equality and inequality constraints. Each one of these is treated next in this paper.

2.2.1.1. *Equality constraint.* The sum of generation from all units is expected to be equal to the load demand taking line losses into consideration. This constraint is as presented in Equation (12).

$$\sum_{j=1}^Q U_j^t P_j^t + \sum_{h=1}^M U_h^t P_h^t - \sum_{l=1}^L P_l = P_D^t \quad (12)$$

2.2.1.2. *Inequality constraints.* To have a minimum deviation, the total power generated that meets the demand must be at minimum; hence Equation (13) holds.

$$\sum_{t=1}^T \sum_{i=1}^N P_i^t \geq P_D^t + P_l \quad (13)$$

#### 2.2.2. Spinning reserve

The spinning reserve, also known as generator reserve, is a percentage of the forecasted peak load demand that can be used quickly in order to face different contingencies. It must be greater than or equal to the minimum power requirement. To meet this requirement, the total power output from the units placed on reserve must be greater than the reserve planned for. This is presented in Equation (14) using hydro unit in this case. Equation (15) therefore relates power demand, spinning requirement and line losses with total output power.

$$\sum_{h=1}^M U_h^t \cdot P_h^t > R^t \quad (14)$$

$$\sum_{j=1}^Q P_j^t U_j^t + \sum_{h=1}^M P_h^t U_h^t \geq P_D^t + R^t + P_l \quad (15)$$

2.2.2.1. *Generation output limits.* Units are built to have minimum and maximum output limits. Therefore during scheduling, units must not be charged to supply power below their minimum or above their maximum level as shown in Equations (16) and (17).

$$\left( P_j^t + P_h^t \right)_{min} \leq P_j^t + P_h^t \leq \left( P_j^t + P_h^t \right)_{max} \quad (16)$$

$$P_{i min}^t \leq P \leq P_{i max}^t \quad (17)$$

2.2.2.2. *Voltage boundary.* In order not to violate the thermal limits of the transmission line, the nominal voltage must lie in-between the minimum and maximum line voltages. The relationship called voltage boundary is depicted in Equation (18).

$$V_{min} \leq V \leq V_{max} \quad (18)$$

2.2.2.3. *Minimum up and down time.* Once a unit is running it has a minimum time it must run (minimum up time) before it is decommitted and when decommitted, it must satisfy the minimum off time (down time) before it could be committed again.

$$X_j^{on}, X_h^{on}(t) \geq T_j^{up}, T_h^{up} \quad (19)$$

$$X_j^{off}, X_h^{off}(t) \geq T_j^{down}, T_h^{down} \quad (20)$$

### 2.3. Economic dispatch

After solving the unit commitment problem and ensured through security analyses that present system is in a secure state, efforts are made to adjust the loading on the individual generators to achieve minimum production cost on minute basis. Therefore the economic division of loads among units committed is known as economic dispatch. Economic dispatch is also a constrained optimisation problem with load demand amongst other constraints. It depends on the heat rate of each unit and the type of fuel used as presented in Equation (2) which comprises unit heat rate (MBTU/h) and the price of fuel (\$/MBTU) to determine the cost (\$/h) of generating power (MW) at a period of 1 h.

#### 2.3.1. Heat rate ( $\zeta$ ) and incremental heat rate ( $\xi$ )

The outputs of the thermal units are dependent on the input, i.e. the heat produced from the fuel. Therefore heat rate expresses the fuel consumed to produce 1 MW of power in 1 h and change in the heat rate gives the incremental heat rate as shown in Equations (21) and (22).

$$\zeta = \frac{\text{Input(MBTU)}}{\text{Output(MW)}} \quad (21)$$

$$\xi = \frac{\Delta \text{Input} \left( \frac{\text{MBTU}}{\text{h}} \right)}{\Delta \text{Output (MW)}} \quad (22)$$

#### 2.3.2. Fuel cost (F) and incremental fuel cost ( $\lambda$ )

The product of fuel price with heat rate and incremental heat rate give fuel cost and incremental fuel cost respectively. However quadratic approximation, which is basically a convex shaped function, is adopted as fuel cost in this study. The fuel cost is presented by Equation (23) and the incremental fuel cost which is a derivative of fuel cost is given by Equation (24).

$$F_j^t = \left[ \alpha_j + \beta_j P_j^t + \gamma_j (P_j^t)^2 \right] \rho_j^t \quad (23)$$

$$\frac{dF_j^t}{dP_j} = \beta_j + 2\gamma_j P_j = \lambda \quad (24)$$

Incremental fuel cost,  $\lambda$ , is the marginal cost, i.e. the cost of producing 1 MW of power by the thermal units.

Hence considering line losses determined by running power flow analyses and power balance constraints, for all the units, Equation (25) derived from Equation (24) is used to determine the incremental fuel cost.

$$\sum_{j=1}^Q \frac{\lambda - \beta_j}{2\gamma_j} = P_D^t + P_L \quad (25)$$

Hence from incremental fuel cost,  $\lambda$ , power generated by each thermal unit is determined by the Equation (26).

$$P_j + P_L = \frac{\lambda - \beta_j}{2\gamma_j} \quad (26)$$

### 3. The proposed method

Exhaustive enumeration is one of the oldest approaches to problem solving with the help of computers. An exhaustive search is often the best way to handle combinatorial optimisation and enumeration problems which usually lack any regular structure. It needs not necessarily visit all of state space  $\mathbf{S}$  in every instance. It may omit a subspace  $S$  of  $\mathbf{S}$  on the basis of a mathematical argument that guarantees that  $S$  cannot contain any solution. However, in a worst case configuration, exhaustive search is forced to visit all states of  $\mathbf{S}$  (Nievergelt, 2000).

For this reason, exhaustive search is sometimes considered inelegant due to the computational time required. It searches over all possible solutions, and not excluding any possibilities, howsoever improbable they may be, thereby making it slow. Notwithstanding, the approach to problem solving is conceptually simple and often effective, as it will almost definitely find a solution to the problem, should there be one (Nievergelt, 2000).

The exhaustive enumeration algorithm used in this study, gives a better solution especially for systems with less than twenty units in most cases as it creates all possible alternatives of the problem. To determine the units to be committed, there are  $2^N$  possible combinations, where  $N$  is the number of units, with status of each unit at each period, and output of each unit at each period as decision variables. Figure 2 presents the flowchart for the method as it applies to the problem at hand.

## 4. Case study system description and characteristics

### 4.1. System description

The proposed algorithm is tested on a system combining hydro and thermal turbines. The Nigerian 330 kV, 24-bus power system shown in Figure 3 sourced from (Akorede, Hizam, Aris, & Ab Kadir, 2009) consists of 7 units comprising 3 hydro and 4 thermal units.

A quadratic cost function model was used for the thermal unit but the water transport and other hydro variables were not included in this model as the hydro units are used at the peak demand period. The operation data which summarises units' properties are shown in Table 1. The cost functions used in this study are as obtained from (Li, Pedroni, & Zio, 2013).

Figure 2. The proposed unit commitment flowchart.

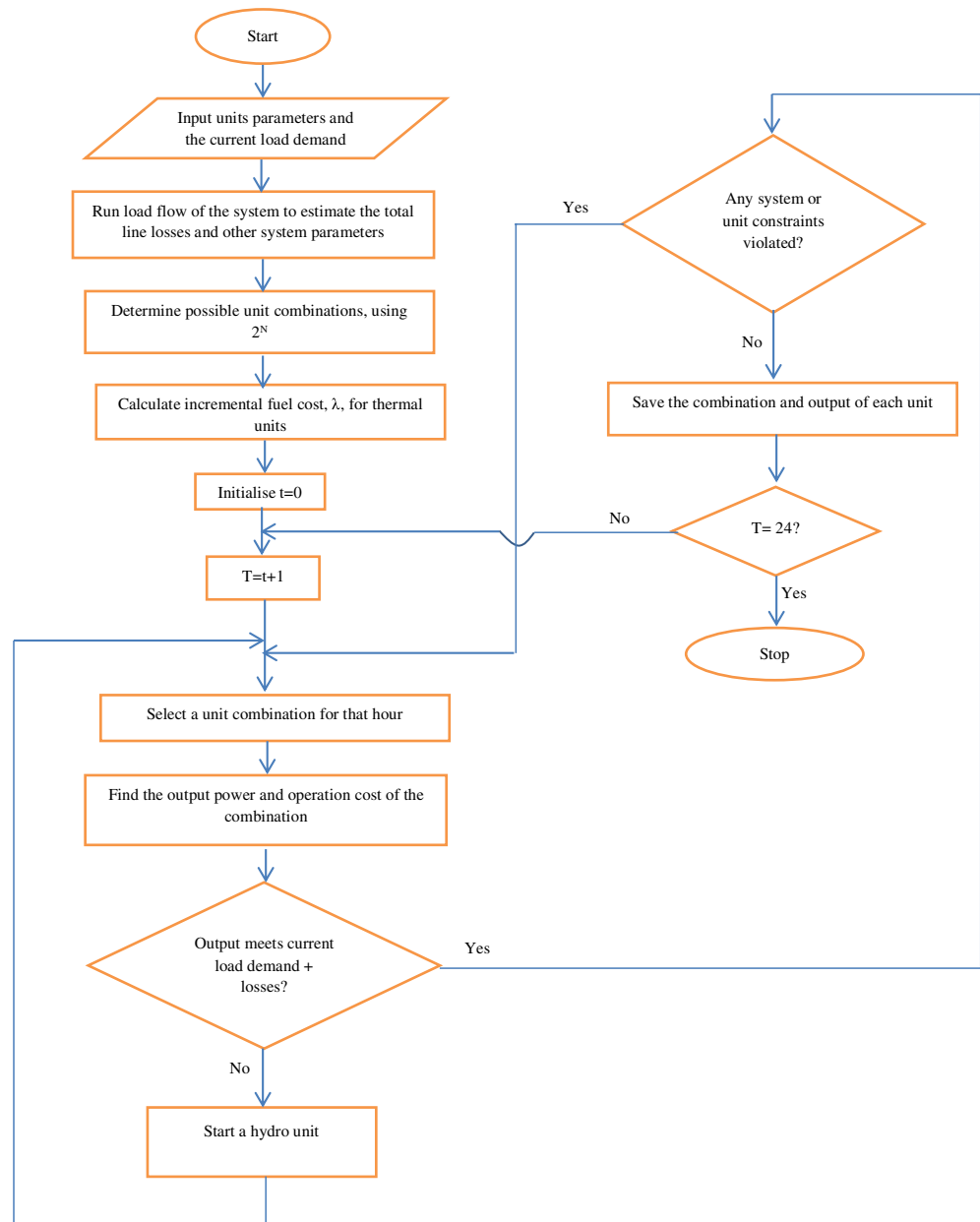
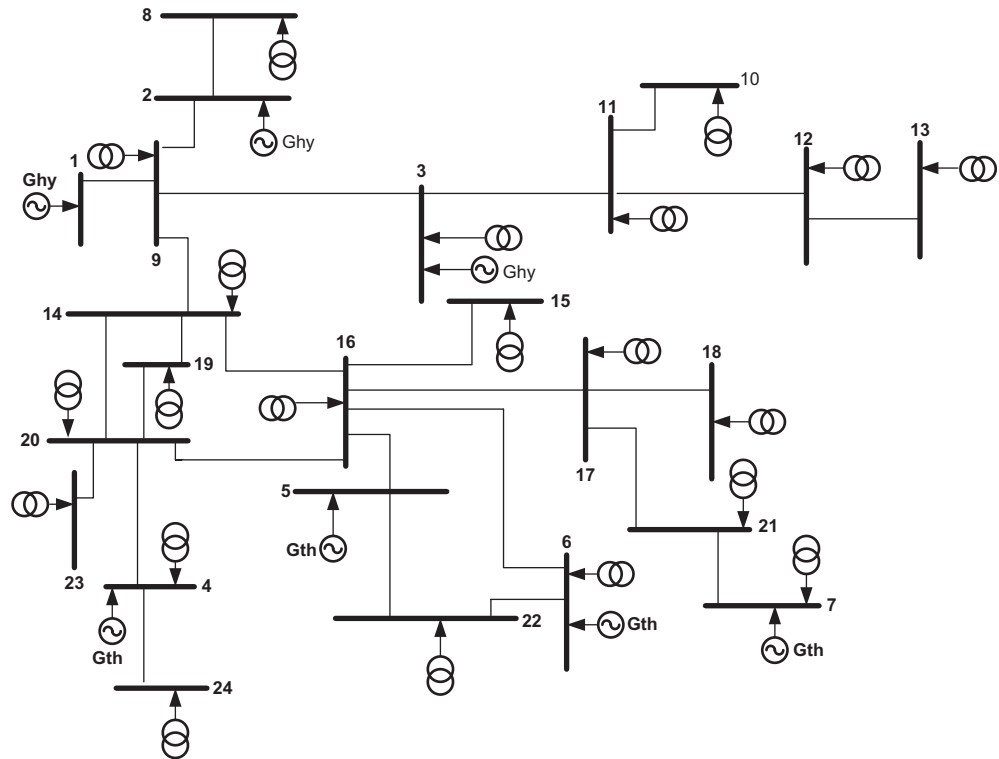

Table 1. Operation data for the 7-unit case study system

Unit	1 (Hy)	2 (Hy)	3 (Hy)	4 (Th)	5 (Th)	6 (Th)	7 (Th)
$P_{max}$ (MW)	150	260	450	445	445	130	162
$P_{min}$ (MW)	10	35	125	150	150	20	25
$\alpha$	0	0	0	1,000	970	700	450
$\beta$	0	0	0	16.19	17.26	16.60	19.70
$\gamma$	0	0	0	0.00048	0.00031	0.002	0.00398
On time (h)	15	15	15	8	8	5	6
Off time (h)	3	3	3	8	8	5	6
Hot start (\$)	0	0	0	4,500	5,000	550	900
Cold start (\$)	0	0	0	9,000	10,000	1,100	1,800
Initial state (h)	0	0	0	8	8	-5	-6



**Figure 3. The test system topology.**



**4.2. Load demand pattern**

The demand for electricity of the case study increases in a varying manner, due to economic and social development. Since electricity cannot be stored, it must be generated and supplied at the point of need—day or night, peak or off peak period. It is a common knowledge that load demand depends on the type of customer’s (e.g. domestic, commercial, industrial, agricultural, etc.) equipment such as heating element, lighting, etc. weather conditions (e.g. outdoor temperature, light), and human factors in forms of consumption patterns, habits, etc. The load demand therefore varies drastically within a given period. The daily load demand profile for 24 h used in this study is presented in Figure 4.

In this study, a steady-state analysis of the electrical power system which provides voltages, currents, real and reactive power flows, line losses, amongst others in a system under a given load condition, was carried out. This is to plan ahead and account for hypothetical situations in power system planning, operation and control (Sastry Musti & Ramkhelawan, 2012). All components of the case study electric power system were modelled and the load flow analysis was carried out in MATPOWER (Zimmerman, Murillo-Sanchez, & Thomas, 2011) to estimate the total system power losses.

**Figure 4. The daily load demand curve of the case study.**

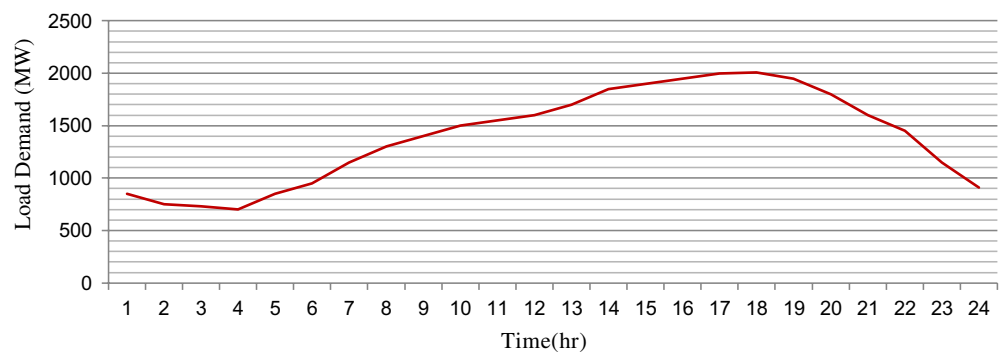

## 5. Results and discussion

The proposed algorithm is tested on the case study system previously described with 24 h horizon. The hydro unit is engaged at the peak period to meet the demand. The result of the hydrothermal system solved with EEA is compared with another method used in planning for a system to supply the same load. Three solutions that meet the power demands are treated under different scenarios described as Case I–III. In all cases, the total daily energy generated is estimated at 33,600 MWh.

### 5.1. Case I

The optimal schedule that met the load demand at the minimum cost, without violating any constraint with the minimum number of transitions from ON to OFF and vice versa is the schedule referred to as Case I. The units combination reveals the *must-run* characteristic of units 4 and 5, while obeying the minimum up and down times. However a small startup cost was incurred by the thermal units whereas the hydro units only incurred the crew cost since they do not run on any fuel. Table 2 presents the units committed and the load allocation for Case I. As the load demand increases the total output from the units also increases either through increase in power output of unit(s) already committed or committing other unit(s) afresh. Total transition of all the units from OFF to ON and vice versa is just eight. As a result, less start-up and shut down costs were incurred. This singular fact supports the choice of Case I being the cost optimal combination.

**Table 2. Daily optimal unit schedule and load allocation for Case I**

Hour (h)	Units committed and economic dispatch (MW)							Load (MW)	Fuel cost (\$)	Startup cost (\$)	Prod. cost (\$)
	1	2	3	4	5	6	7				
0	0	0	0	425	425	0	0	850	14,960.00	-	14,960.00
1	0	0	0	425	325	0	0	750	13,200.00	-	13,200.00
2	0	0	0	425	305	0	0	730	12,848.00	-	12,848.00
3	0	0	0	425	275	0	0	700	12,320.00	-	12,320.00
4	0	0	0	425	425	0	0	850	14,960.00	-	14,960.00
5	60	0	0	445	445	0	0	950	15,664.00	-	15,664.00
6	130	0	0	445	445	130	0	1,150	17,952.00	1,100.00	19,052.00
7	130	0	0	445	445	130	150	1,300	20,592.00	1,800.00	22,392.00
8	130	0	100	445	445	130	150	1,400	20,592.00	-	20,592.00
9	130	0	188	445	445	130	162	1,500	20,803.20	-	20,803.20
10	130	0	238	445	445	130	162	1,550	20,803.20	-	20,803.20
11	130	0	288	445	445	130	162	1,600	20,803.20	-	20,803.20
12	130	0	338	445	445	130	162	1,700	20,803.20	-	20,803.20
13	130	38	450	445	445	130	162	1,850	20,803.20	-	20,803.20
14	130	88	450	445	445	130	162	1,900	20,803.20	-	20,803.20
15	130	260	450	445	445	130	90	1,950	19,536.00	-	19,536.00
16	130	260	450	445	445	130	140	2,000	20,416.00	-	20,416.00
17	130	260	450	445	445	130	150	2,010	20,592.00	-	20,592.00
18	130	260	450	445	445	130	90	1,950	19,536.00	-	19,536.00
19	130	260	450	445	445	70	0	1,800	16,896.00	-	16,896.00
20	130	260	450	445	315	0	0	1,600	13,376.00	-	13,376.00
21	0	260	450	445	295	0	0	1,450	13,024.00	-	13,024.00
22	0	260	450	220	220	0	0	1,150	7,744.00	-	7,744.00
23	0	260	450	100	100	0	0	910	3,520.00	-	3,520.00
Total								33,600	402,547.20	2,900.00	405,447.20

**Figure 5. Contributions of hydro and thermal units for Case I.**

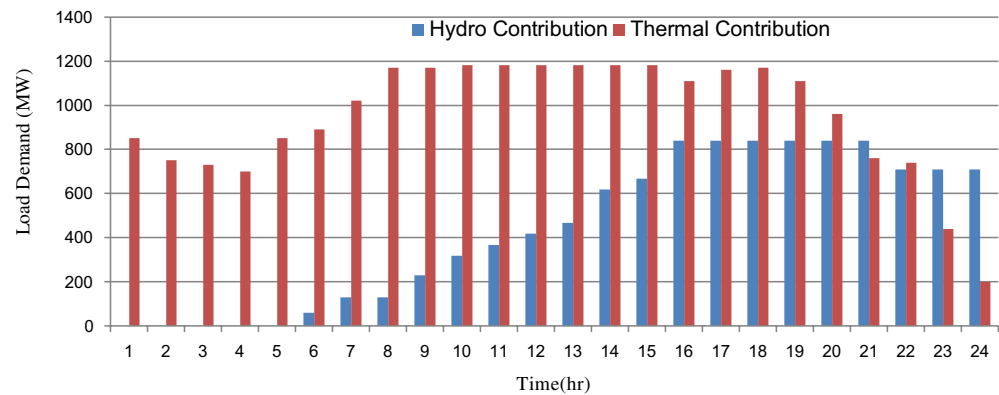

Figure 5, presents the contribution of hydro and thermal units which met the total load demand. It is observed that thermal units were all ON throughout the period under consideration while commitment of hydro units started at the sixth hour when the committed thermal units (units 4 and 5) could no longer meet the required load demand. The committed thermal units contributed the same amount of power from the tenth to fifteenth hour. This is because starting another thermal unit at that particular time will lead to incurring more cost due to cold startup since all other available thermal units have lost their operating temperature.

**Table 3. Unit schedule and load allocation for Case II**

Hour (h)	Units committed and economic dispatch (MW)							Load (MW)	Fuel cost (\$)	Startup cost (\$)	Prod. cost (\$)
	1	2	3	4	5	6	7				
0	130	0	0	445	0	130	145	850	12,672.00	2,900.00	15,572.00
1	30	0	0	445	0	130	145	750	12,672.00	-	12,672.00
2	10	0	0	445	0	130	145	730	12,672.00	-	12,672.00
3	0	0	0	445	0	110	145	700	12,320.00	-	12,320.00
4	130	0	0	445	0	130	145	850	12,672.00	-	12,672.00
5	0	213	0	445	0	130	162	950	12,971.20	-	12,971.20
6	130	0	445	445	0	130	0	1,150	10,120.00	-	10,120.00
7	130	0	445	445	0	130	150	1,300	12,760.00	900.00	13,660.00
8	130	250	445	445	0	130	0	1,400	10,120.00	-	10,120.00
9	130	0	445	445	350	130	0	1,500	16,280.00	10,000.00	26,280.00
10	130	0	450	445	395	130	0	1,550	17,072.00	-	17,072.00
11	0	0	450	445	445	130	130	1,600	20,240.00	900.00	21,140.00
12	0	230	450	445	445	130	0	1,700	17,952.00	-	17,952.00
13	120	260	450	445	445	130	0	1,850	17,952.00	-	17,952.00
14	120	260	450	445	445	130	50	1,900	18,832.00	900.00	19,732.00
15	120	260	450	445	445	130	100	1,950	19,712.00	-	19,712.00
16	120	260	450	445	445	130	150	2,000	20,592.00	-	20,592.00
17	130	260	450	445	445	130	150	2,010	20,592.00	-	20,592.00
18	120	260	450	445	445	130	100	1,950	19,712.00	-	19,712.00
19	120	260	450	445	295	130	100	1,800	17,072.00	-	17,072.00
20	130	0	450	445	445	0	130	1,600	17,952.00	-	17,952.00
21	130	0	430	445	445	0	0	1,450	15,664.00	-	15,664.00
22	130	0	445	445	0	130	0	1,150	10,120.00	550.00	10,670.00
23	130	205	0	445	0	130	0	910	10,120.00	-	10,120.00
Total								33,600	368,843.20	16,150.00	384,993.20

### 5.2. Case II

In this scenario presented in Table 3, the units scheduled are able to produce the required power at a lower cost when compared to Case I. It is assumed here that none of the units generated beyond either the minimum or maximum limit. However, quite a number of other constraints were violated. The *must-run* characteristic of unit 5 was stepped down and there are more transitions of units from ON to OFF and vice versa in 26 different times. This causes the units to violate minimum up and minimum down time constraints as in units 1, 2, 6 and 7. The startup cost incurred is high because of the number of transitions. The portion coloured red shows the area where either minimum up time or/and minimum down time constraints were violated, while the blue portion indicates violation of the *must-run* characteristics.

Figure 6 shows the pattern of the contributions of the hydro and thermal units in meeting the load demand in Case II. The hydro units were committed right from the first hour despite the fact that the *must-run* units 4 and 5 can meet the load demand at this time. In other words, the *must-run* condition was violated. Again, it is noticed that the figure demonstrates an irregular pattern that does not resemble the load demand curve. This is because unit 5, a *must-run* unit, was not committed at the appropriate time, which consequently results in high startup cost, even as the cost incurred was reduced at the peak period.

**Figure 6. Contributions of hydro and thermal units for Case II.**

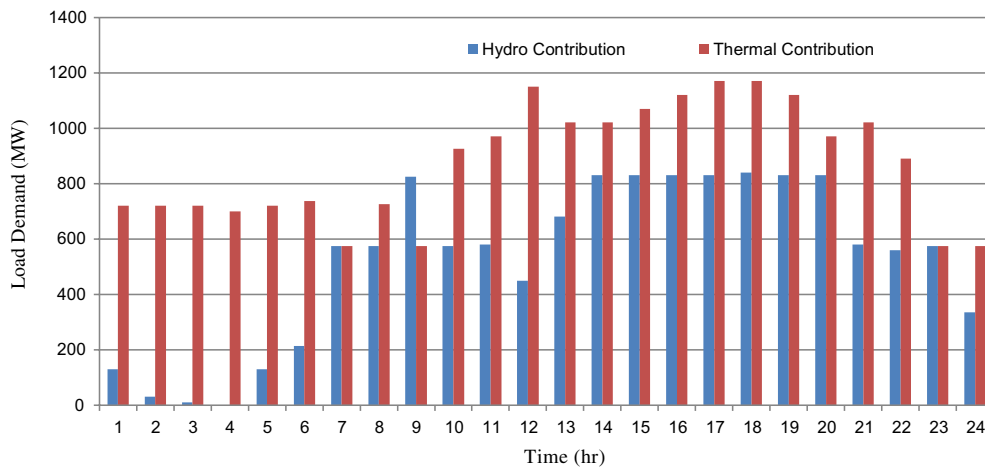

**Figure 7. Contributions of hydro and thermal unit for Case III.**

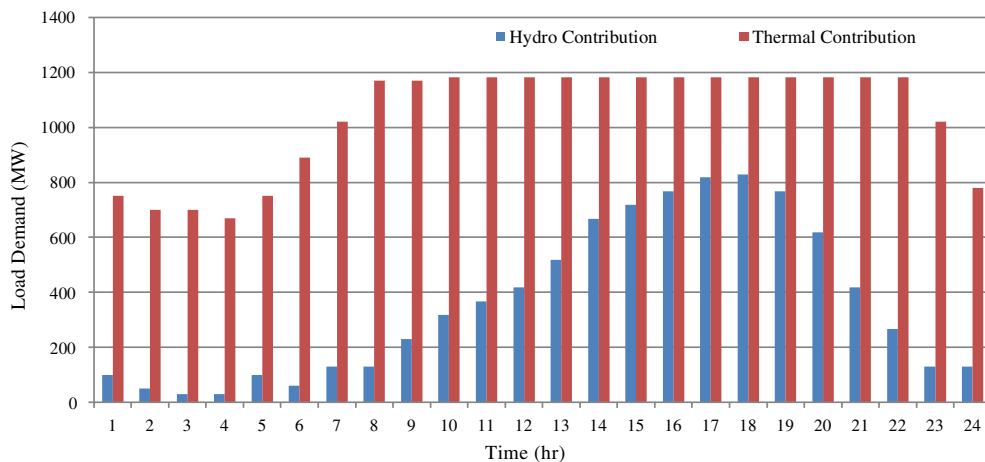

**Table 4. Unit schedule and load allocation for Case III**

Hour (h)	Units committed and economic dispatch (MW)							Load (MW)	Fuel cost (\$)	Startup cost (\$)	Prod. cost (\$)
	1	2	3	4	5	6	7				
0	100	0	0	400	350	0	0	850	13,200.00	-	13,200.00
1	50	0	0	400	300	0	0	750	12,320.00	-	12,320.00
2	30	0	0	400	300	0	0	730	12,320.00	-	12,320.00
3	30	0	0	400	270	0	0	700	11,792.00	-	11,792.00
4	100	0	0	400	350	0	0	850	13,200.00	-	13,200.00
5	60	0	0	445	445	0	0	950	15,664.00	-	15,664.00
6	130	0	0	445	445	130	0	1,150	17,952.00	1,100.00	19,052.00
7	130	0	0	445	445	130	150	1,300	20,592.00	1,800.00	22,392.00
8	130	100	0	445	445	130	150	1,400	20,592.00	-	20,592.00
9	130	188	0	445	445	130	162	1,500	20,803.20	-	20,803.20
10	130	238	0	445	445	130	162	1,550	20,803.20	-	20,803.20
11	130	0	288	445	445	130	162	1,600	20,803.20	-	20,803.20
12	130	0	388	445	445	130	162	1,700	20,803.20	-	20,803.20
13	130	88	450	445	445	130	162	1,850	20,803.20	-	20,803.20
14	130	138	450	445	445	130	162	1,900	20,803.20	-	20,803.20
15	130	188	450	445	445	130	162	1,950	20,803.20	-	20,803.20
16	130	238	450	445	445	130	162	2,000	20,803.20	-	20,803.20
17	130	248	450	445	445	130	162	2,010	20,803.20	-	20,803.20
18	130	188	450	445	445	130	162	1,950	20,803.20	-	20,803.20
19	130	188	300	445	445	130	162	1,800	20,803.20	-	20,803.20
20	130	0	288	445	445	130	162	1,600	20,803.20	-	20,803.20
21	130	0	138	445	445	130	162	1,450	20,803.20	-	20,803.20
22	130	0	0	445	445	130	0	1,150	17,952.00	-	17,952.00
23	130	0	0	445	335	0	0	910	13,728.00	-	13,728.00
Total								33,600	439,753.60	2,900.00	442,653.60

**Figure 8. Daily power demand vs. production cost for all cases.**

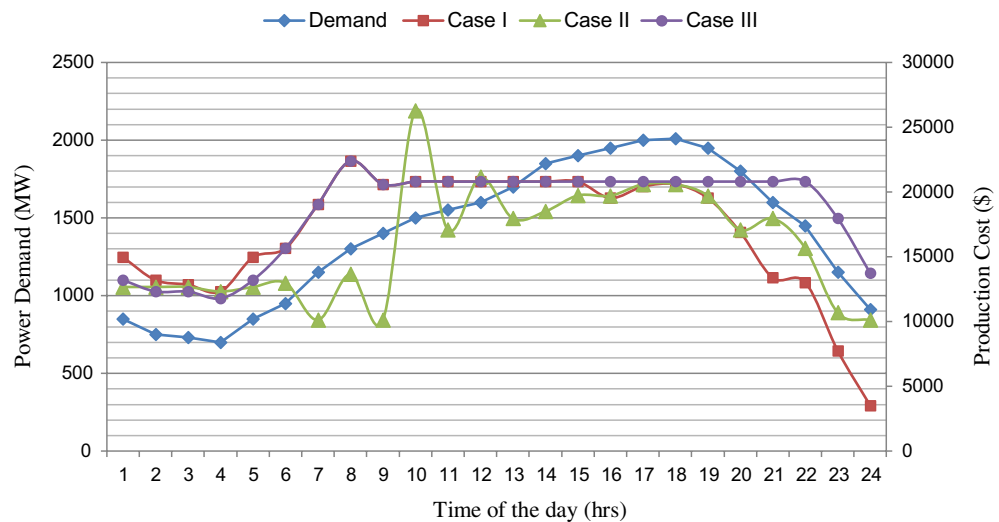

**Table 5. Comparison of results with the existing works**

Method	Type of system	No. of units	Total production cost (\$)
Exhaustive enumeration	Thermal	10	493,061.00
Quantum-inspired binary PSO (Jeong et al., 2010)			563,977.00
Exhaustive enumeration	Hydro-Thermal	10	684,390.00
Memetic evolutionary algorithm (Li et al., 2013)			705,329.29

### 5.3. Case III

Despite the fact that only one constraint was violated in Case III and ten transitions were recorded as presented in Table 4, yet the cost of production was the highest. The reason for this is that the order by which the units were committed was wrong. For example, unit 1 was committed from the first hour. Therefore it cannot be economical to adopt such plan as an optimal combination.

The contributions of hydro and thermal units towards the total load demand are presented in Figure 7. Here the hydro units are committed throughout the 24 h period, even though not optimally utilised. The uneconomical dispatch from the thermal units results in a high total production cost.

### 5.4. Generated power vs. production cost for all cases

Figure 8 presents the relationship between power generated and cost of production for the three scenarios considered in this study. Case I shows that the generated power is proportional to the cost of production. The total production cost for this case from the graph is \$405,447.20. However, it is observed in Case II that the production cost incurred is irregular in nature as the highest cost (peak) was incurred at the tenth hour when the demand is just a bit above the off peak demand. The reason for this is that unit 5, a *must-run* unit was not committed at the appropriate time, which leads to a high startup cost experienced at the tenth hour. Though the total production cost for this case is \$384,993.20, which should have been preferred to case I, the fact that there was minimum up and down times constraint violation work against the choice of this CASE as optimal. Case III is the worst scenario as it incurs the highest total production cost of \$442,653.60 and still violates some set of system constraints.

### 5.5. Comparison of simulation results

The proposed algorithm was used for data from published articles and the obtained results were compared with the published results as presented in Table 5. Due to the increase in the number of units, the feasible solution space and the computation time increased. However, optimal results were obtained from Exhaustive Enumeration which gives the best unit combination at the minimum total production cost.

## 6. Conclusion

This study has presented a classical exhaustive enumeration algorithm for solving unit commitment problem in power systems containing hydro and thermal units. Though the method, based on brute force analysis, may be tasking, slow and time consuming, the comparative analysis of the results obtained in this paper has reaffirmed its efficiency, most especially when applied to systems with less than 20 units. In this study, two objective functions were formulated and solved. The objective of the formulation was to find the minimum generation cost for meeting the demand and reserve requirement in each hour of the scheduling horizon by finding one feasible sequence of ON-OFF states. The approach was applied on the Nigeria 330 kV national grid containing 24 buses. The results obtained established that the approach is an effective optimisation technique which reveals that optimal unit scheduling results in huge savings for the utilities. However, the efficiency of the approach is limited as the size and complexity of the test system increases.

## Nomenclature

$t$	time index
$T$	time horizon of scheduling (h)
$i$	unit index
$h$	hydro unit index
$j$	thermal unit index
$A_1$	total production cost
$A_2$	expected deviation
$\theta$	cost of running thermal units
$\phi$	cost of running hydro units
$\rho_j^t$	fuel price (N/MBTU)
$P_j^t$	output power of $j$ th thermal unit at time $t$ (MW)
$\alpha_j, \beta_j$ and $\gamma_j$	are cost constant
$F_j^t$	fuel cost of $j$ th unit at time $t$ (N)
$S_j^t$	start up cost of $j$ th thermal unit at time $t$ (N/h)
$D_j^t$	shut down cost of $j$ th thermal unit at time $t$ (N/h) which is practically zero for ideal system
$C$	crew expenses
$O_j^t$	cost of maintaining unit at operating temperature
$K$	cold start up cost
$B$	bank start up cost
$Q$	total number of thermal unit
$M$	total number of hydro-unit
$N$	total number of unit
$P_i^t$	total power output from both hydro and thermal units
$P_l$	total line loss
$U_j^t$ and $U_h^t$	$j$ th thermal and $h$ th hydro unit status respectively
$P_h^t$	output power of $h$ th hydro unit
$P_D^t$	total forecasted system load demand at time $t = 1, 2, \dots, T$
$L$	number of transmission line
$R^t$	system spinning reserve at time $t = 1, 2, \dots, H$
$V_{\min}$	minimum line voltage
$V$	nominal line voltage
$V_{\max}$	maximum line voltage
$X$	running time
$T^{up}, T^{down}$	minimum up or down time
$t_j$	cooled time of thermal unit
$\tau_j$	time constant of $j$ th thermal unit

## Funding

The authors received no direct funding for this research.

## Author details

S.A. Bello<sup>1</sup>

E-mail: [saeedbello01@gmail.com](mailto:saeedbello01@gmail.com)

M.F. Akorede<sup>1</sup>

E-mails: [mudathira30@gmail.com](mailto:mudathira30@gmail.com), [akorede@unilorin.edu.ng](mailto:akorede@unilorin.edu.ng)

E. Pouresmaeil<sup>2</sup>

E-mail: [edris.pouresmaeil@gmail.com](mailto:edris.pouresmaeil@gmail.com)

O. Ibrahim<sup>1</sup>

E-mail: [reacholaibrahim@gmail.com](mailto:reacholaibrahim@gmail.com)

<sup>1</sup> Department of Electrical and Electronics Engineering, University of Ilorin, Ilorin, Nigeria.

<sup>2</sup> INESC-ID, Instituto Superior Técnico, University of Lisbon, Av. Rovisco Pais, 1, Lisbon 1049-001, Portugal.

## Citation information

Cite this article as: Unit commitment optimisation of hydro-thermal power systems in the day-ahead electricity market, S.A. Bello, M.F. Akorede, E. Pouresmaeil & O. Ibrahim, *Cogent Engineering* (2016), 3: 1251009.

## References

- Akorede, M. F., Hizam, H., Aris, I., & Ab Kadir, M. Z. A. (2009). contingency evaluation for voltage security assessment of power systems. In *IEEE 2009 Student Conference on Research and Development* (pp. 345–348). Serdang: Universiti Putra Malaysia.
- Bai, Q. (2010). Analysis of PSO algorithm. *Computer and Information Science*, 3, 180–184.
- Balci, H. H., & Valenzuela, J. F. (2004). Scheduling electric power generator using PSO combined with lagrangian Relaxation method. *International Journal, Applied Maths and Computer Science*, 14, 411–421.
- Bavafa, M., Monsef, H., & Navidi, N. (2009). *A new hybrid approach for Unit commitment using Langrange relaxation combined with evolutionary and quadratic programming* (pp. 1–6). University of Tehran, Tehran.
- Bayoumi, A. M. (2014). Exhaustive enumeration algorithm for the two-stage supply chain distribution problem. *Minia Journal of Engineering and Technology (MJET)*, 33, 164–172.
- Columbus, C. C., & Simon, S. P. (2013). Profit based unit commitment for GENCOs using parallel NACO in a distributed cluster. *Swarm and Evolutionary Computation*, 10, 41–58.
- Dhillon, J. S., Parti, S. C., & Kothari, D. P. (2001). Fuzzy decision making in multi-objective long-term scheduling of hydro-thermal system. *International Journal of Electrical Power and Energy Systems*, 23, 19–29.
- El-Hawary, M. E., & Christenson, G. S. (2012). *Optimal economic operation of power system*. New York, NY: Academic Press.
- Ioannis, G. D., Anastasios, G. B., & Petros, S. D. (2004). A solution to the unit-commitment problem using integer-coded genetic algorithm. *IEEE Transactions on Power System*, 19, 1165–1172.
- Jeong, Y-W, Park, J-B, Jang, S-H., & Lee, K. Y. (2010). A new quantum-inspired binary PSO: Application to unit commitment problems for power systems. *IEEE Transactions on Power Systems*, 25, 1486–1495.
- Kluabwang, J. (2012). Economical operation of hydro-thermal power system based on multi-path adaptive Tabu-search. *International Journal of Electrical, Computer, Energetic, Electronic and Communication Engineering*, 6, 477–479.
- Li, Y. F., Pedroni, N., & Zio, E. (2013). A memetic evolutionary multi-objective optimization method for environmental power unit commitment. *IEEE Transactions on Power System*, 28, 2660–2669.
- Najafi, S., & Pourjamal, Y. (2012). A new heuristic algorithm for unit commitment problem. *Energy Procedia*, 14, 2005–2011.  
<http://dx.doi.org/10.1016/j.egypro.2011.12.1201>
- Nievergelt, J. (2000). Exhaustive search, combinatorial optimization and enumeration: Exploring the potential of raw computing power. In *Sofsem 2000: Theory and practice of informatics* (pp. 18–35). Berlin: Springer, Berlin Heidelberg.
- Orero, S. O., & Irving, M. R. (1998). A genetic algorithm modelling framework and solution technique for short term optimal hydrothermal scheduling. *IEEE Transactions on Power Systems*, 13, 501–518.  
<http://dx.doi.org/10.1109/59.667375>
- Ouyang, Z., & Shahidehpour, S. M. (1991). An intelligent dynamic programming for unit commitment application. *IEEE Transactions on Power Systems*, 6, 1203–1209.  
<http://dx.doi.org/10.1109/59.119267>
- Puri, V., Narang, N., Jain, S. K., & Chauhan, Y. K. (2012). Unit commitment using particle swarm optimisation. *BIOINFO Computational Optimisation*, 2, 9–16.
- Revathy, K., & Nithiyandham, C. (2014). Economic dispatch using PSO. *International Journal of Advanced Research in Electrical, Electronics and Instrumentation Engineering*, 3, 59–66.
- Saber, A. Y., Senjyu, T., Miyagi, T., Urasaki, N., & Funabashi, T. (2006). Fuzzy unit commitment scheduling using absolutely stochastic simulated annealing. *IEEE Transactions on Power Systems*, 21, 955–964.  
<http://dx.doi.org/10.1109/TPWRS.2006.873017>
- Sastry Musti, K. S., & Ramkhelawan, R. B. (2012). Power system load flow analysis using Microsoft excel. *Spreadsheet in Education*, 6, 1–19.
- Tingfang, Y., & Ting, T. O. (2008). Methodological priority list of unit commitment problems. In *Conference Proceedings of the International Conference on Computer Science and Software Engineering* (pp. 176–179). Wuhan.
- Wood, A. J., & Wollenberg, B. F. (1996). *Power Generation, Operation and Control* (2nd ed.). New York, NY: John Wiley & Sons.
- Yalcinoz, T., Cory, B. J., & Short, M. J. (2001). Hopfield neural network approaches to economic dispatch problems. *International Journal of Electrical Power and Energy System*, 23, 435–442.
- Yan, H., Luh, P. B., Guan, X., & Rogan, P. M. (1993). Scheduling of hydrothermal power systems. *IEEE Transactions on Power System*, 8, 1358–1365.
- Yin Wa Wong, S. (2001). Hybrid simulated annealing/genetic algorithm approach to short-term hydro-thermal scheduling with multiple thermal plants. *International Journal of Electrical Power & Energy Systems*, 23, 565–575.  
[http://dx.doi.org/10.1016/S0142-0615\(00\)00029-6](http://dx.doi.org/10.1016/S0142-0615(00)00029-6)
- Zimmerman, R. D., Murillo-Sanchez, C. E., & Thomas, R. J. (2011, February). MATPOWER: Steady-state operations, planning, and analysis tools for power systems research and education. *IEEE Transactions on Power Systems*, 26, 12–19. <http://dx.doi.org/10.1109/TPWRS.2010.2051168>
- Zivic, D. M., Milacic, A., & Krsulja, M. A. (2012). Simplified model of quadratic cost function for thermal generators. *23rd International Symposium in Austria*, 23, 25–28.



© 2016 The Author(s). This open access article is distributed under a Creative Commons Attribution (CC-BY) 4.0 license.

You are free to:

Share — copy and redistribute the material in any medium or format

Adapt — remix, transform, and build upon the material for any purpose, even commercially.

The licensor cannot revoke these freedoms as long as you follow the license terms.

Under the following terms:

Attribution — You must give appropriate credit, provide a link to the license, and indicate if changes were made.

You may do so in any reasonable manner, but not in any way that suggests the licensor endorses you or your use.

No additional restrictions

You may not apply legal terms or technological measures that legally restrict others from doing anything the license permits.

